

SIPMOS[®] Small-Signal Transistor

- N channel
- Enhancement mode
- $V_{GS(th)} = 1.5 \dots 2.5 \text{ V}$

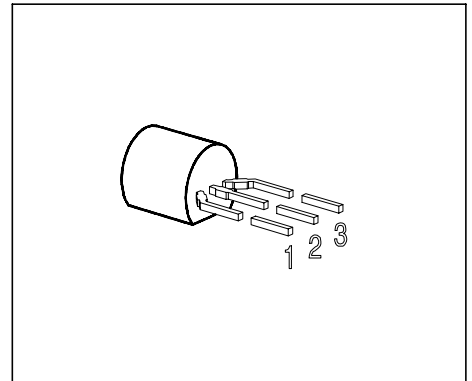

Pin 1	Pin 2	Pin 3
G	D	S

Type	V_{DS}	I_D	$R_{DS(on)}$	Package	Marking
BSS 124	400 V	0.12 A	28 Ω	TO-92	SS 124

Type	Ordering Code	Tape and Reel Information
BSS 124	Q67000-S172	E6288

Maximum Ratings

Parameter	Symbol	Values	Unit
Drain source voltage	V_{DS}	400	V
Drain-gate voltage $R_{GS} = 20 \text{ k}\Omega$	V_{DGR}	400	
Gate source voltage	V_{GS}	± 14	
Gate-source peak voltage, aperiodic	V_{gs}	± 20	
Continuous drain current $T_A = 37 \text{ }^\circ\text{C}$	I_D	0.12	A
DC drain current, pulsed $T_A = 25 \text{ }^\circ\text{C}$	I_{Dpuls}	0.48	
Power dissipation $T_A = 25 \text{ }^\circ\text{C}$	P_{tot}	1	W

Maximum Ratings

Parameter	Symbol	Values	Unit
Chip or operating temperature	T_j	-55 ... + 150	°C
Storage temperature	T_{stg}	-55 ... + 150	
Thermal resistance, chip to ambient air ¹⁾	R_{thJA}	≤ 125	K/W
DIN humidity category, DIN 40 040		E	
IEC climatic category, DIN IEC 68-1		55 / 150 / 56	

Electrical Characteristics, at $T_j = 25^\circ\text{C}$, unless otherwise specified

Parameter	Symbol	Values			Unit
		min.	typ.	max.	

Static Characteristics

Drain- source breakdown voltage $V_{GS} = 0 \text{ V}$, $I_D = 0.25 \text{ mA}$, $T_j = 25 \text{ }^\circ\text{C}$	$V_{(BR)DSS}$	400	-	-	V
Gate threshold voltage $V_{GS} = V_{DS}$, $I_D = 1 \text{ mA}$	$V_{GS(th)}$	1.5	2	2.5	
Zero gate voltage drain current $V_{DS} = 400 \text{ V}$, $V_{GS} = 0 \text{ V}$, $T_j = 25 \text{ }^\circ\text{C}$ $V_{DS} = 400 \text{ V}$, $V_{GS} = 0 \text{ V}$, $T_j = 125 \text{ }^\circ\text{C}$	I_{DSS}	-	0.1 8	1 50	μA
Gate-source leakage current $V_{GS} = 20 \text{ V}$, $V_{DS} = 0 \text{ V}$	I_{GSS}	-	10	100	nA
Drain-Source on-state resistance $V_{GS} = 10 \text{ V}$, $I_D = 0.12 \text{ A}$	$R_{DS(on)}$	-	16	28	Ω

Electrical Characteristics, at $T_j = 25^\circ\text{C}$, unless otherwise specified

Parameter	Symbol	Values			Unit
		min.	typ.	max.	

Dynamic Characteristics

Transconductance $V_{DS} \geq 2 * I_D * R_{DS(on)max}, I_D = 0.12 \text{ A}$	g_{fs}	0.1	0.19	-	S
Input capacitance $V_{GS} = 0 \text{ V}, V_{DS} = 25 \text{ V}, f = 1 \text{ MHz}$	C_{iss}	-	90	120	pF
Output capacitance $V_{GS} = 0 \text{ V}, V_{DS} = 25 \text{ V}, f = 1 \text{ MHz}$	C_{oss}	-	10	15	
Reverse transfer capacitance $V_{GS} = 0 \text{ V}, V_{DS} = 25 \text{ V}, f = 1 \text{ MHz}$	C_{rss}	-	4	6	
Turn-on delay time $V_{DD} = 30 \text{ V}, V_{GS} = 10 \text{ V}, I_D = 0.21 \text{ A}$ $R_G = 50 \Omega$	$t_{d(on)}$	-	5	8	ns
Rise time $V_{DD} = 30 \text{ V}, V_{GS} = 10 \text{ V}, I_D = 0.21 \text{ A}$ $R_G = 50 \Omega$	t_r	-	10	15	
Turn-off delay time $V_{DD} = 30 \text{ V}, V_{GS} = 10 \text{ V}, I_D = 0.21 \text{ A}$ $R_G = 50 \Omega$	$t_{d(off)}$	-	18	25	
Fall time $V_{DD} = 30 \text{ V}, V_{GS} = 10 \text{ V}, I_D = 0.21 \text{ A}$ $R_G = 50 \Omega$	t_f	-	15	20	

Electrical Characteristics, at $T_j = 25^\circ\text{C}$, unless otherwise specified

Parameter	Symbol	Values			Unit
		min.	typ.	max.	

Reverse Diode

Inverse diode continuous forward current $T_A = 25^\circ\text{C}$	I_S	-	-	0.12	A
Inverse diode direct current, pulsed $T_A = 25^\circ\text{C}$	I_{SM}	-	-	0.48	
Inverse diode forward voltage $V_{GS} = 0\text{ V}, I_F = 0.24\text{ A}$	V_{SD}	-	0.85	1.3	V

Power dissipation

$$P_{\text{tot}} = f(T_A)$$

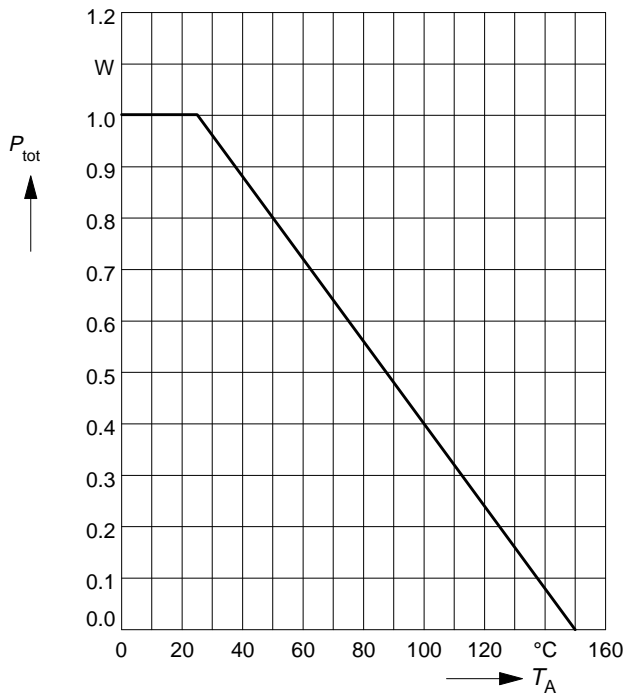

Drain current

$$I_D = f(T_A)$$

parameter: $V_{GS} \geq 10 \text{ V}$

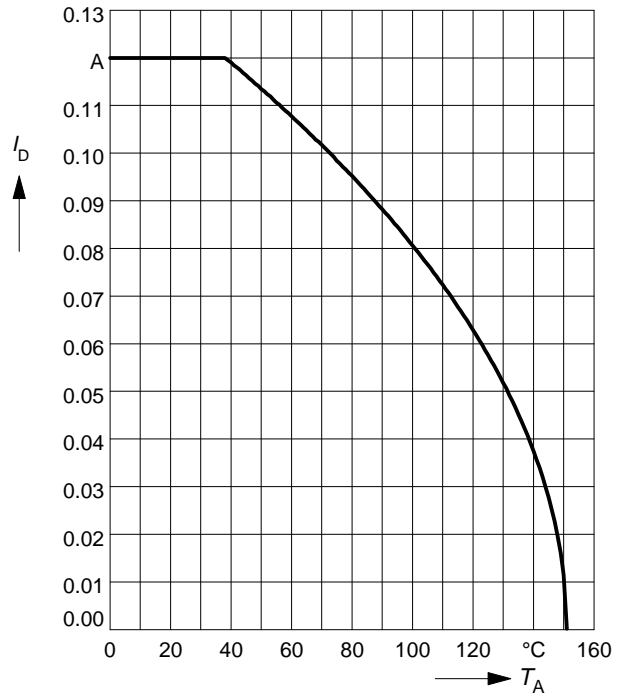

Safe operating area $I_D = f(V_{DS})$

parameter: $D = 0.01$, $T_C = 25^\circ\text{C}$

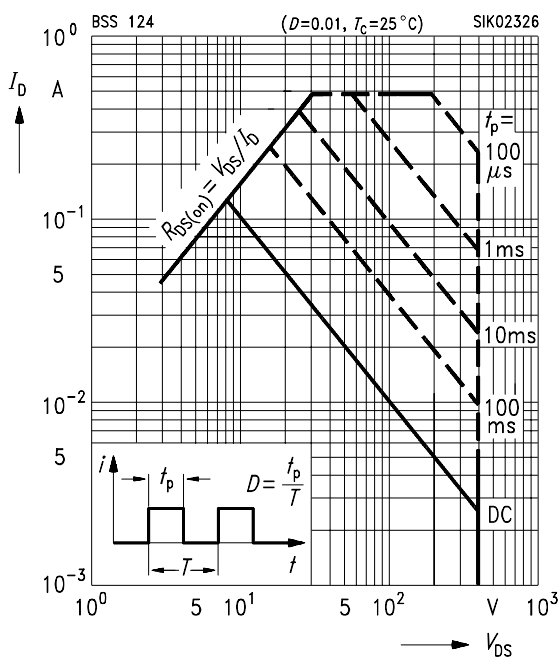

Drain-source breakdown voltage

$$V_{(BR)DSS} = f(T_j)$$

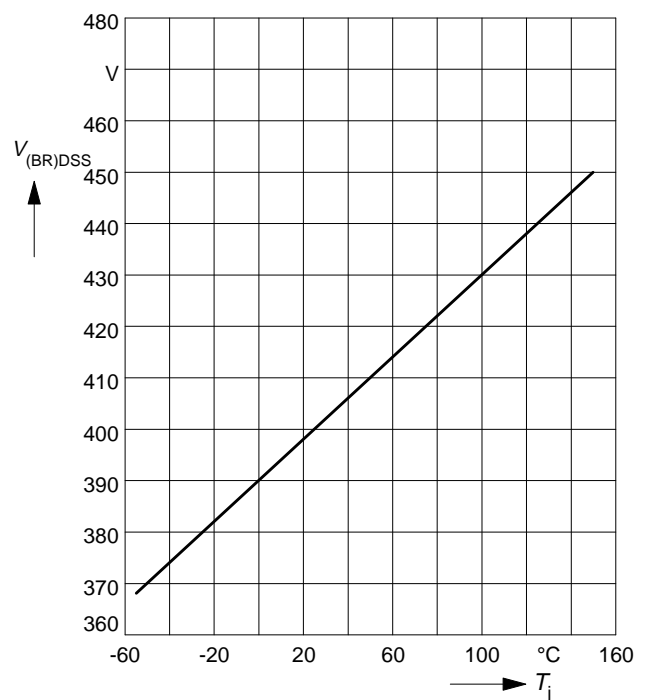

Typ. output characteristics

$$I_D = f(V_{DS})$$

parameter: $t_p = 80 \mu s$, $T_j = 25 \text{ }^\circ\text{C}$

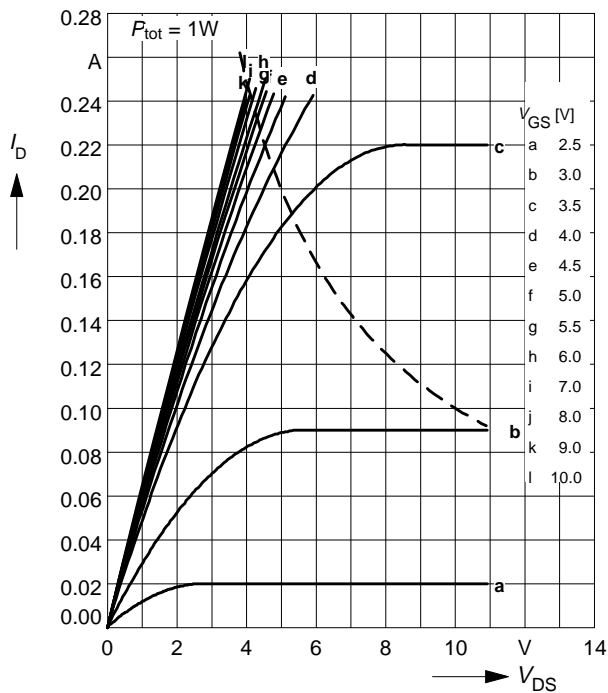

Typ. drain-source on-resistance

$$R_{DS(on)} = f(I_D)$$

parameter: $t_p = 80 \mu s$, $T_j = 25 \text{ }^\circ\text{C}$

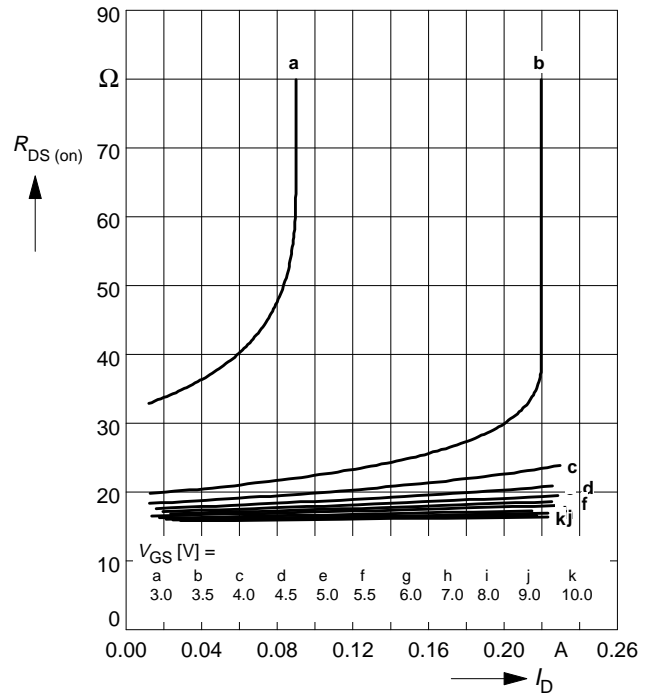

Typ. transfer characteristics $I_D = f(V_{GS})$

parameter: $t_p = 80 \mu s$

$V_{DS} \geq 2 \times I_D \times R_{DS(on)max}$

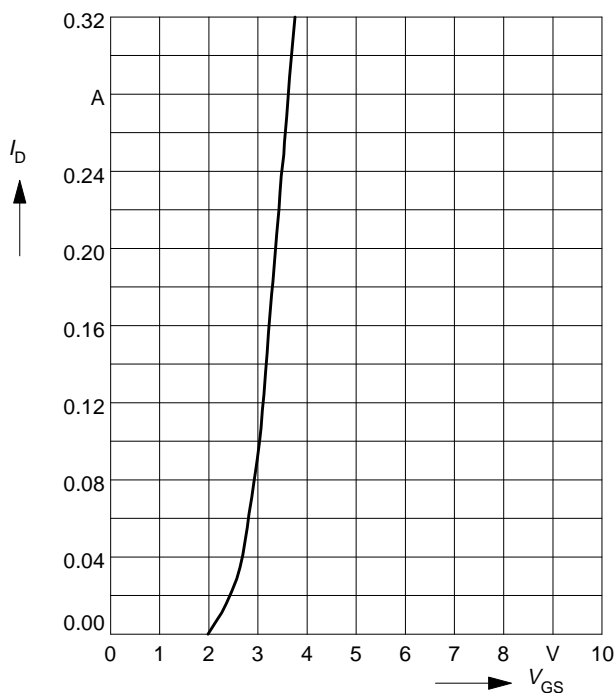

Typ. forward transconductance $g_{fs} = f(I_D)$

parameter: $t_p = 80 \mu s$,

$V_{DS} \geq 2 \times I_D \times R_{DS(on)max}$

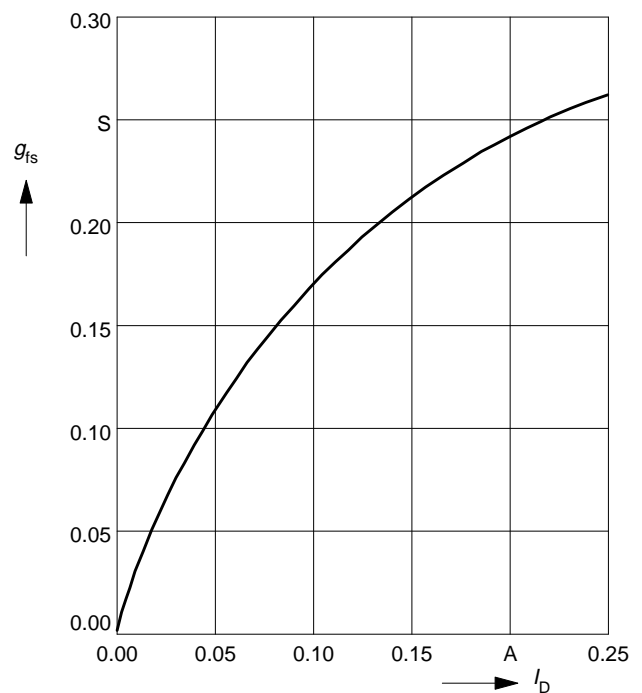

Drain-source on-resistance

$$R_{DS(on)} = f(T_j)$$

parameter: $I_D = 0.12 \text{ A}$, $V_{GS} = 10 \text{ V}$

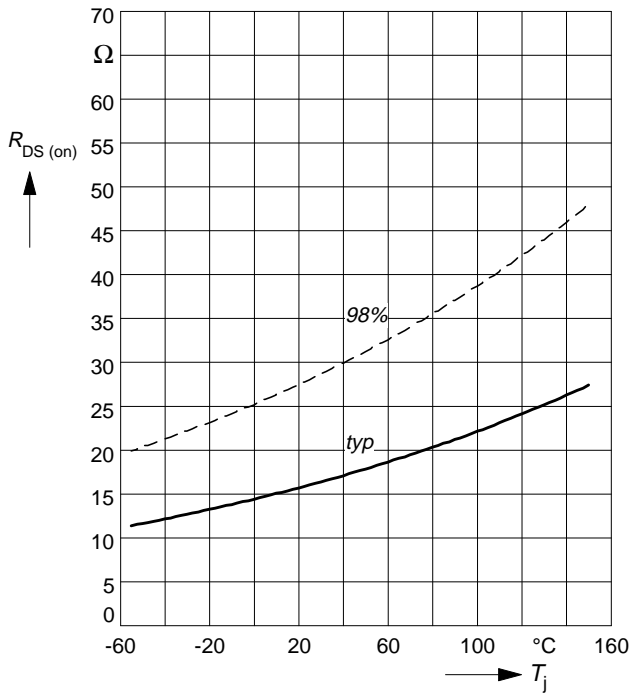

Gate threshold voltage

$$V_{GS(th)} = f(T_j)$$

parameter: $V_{GS} = V_{DS}$, $I_D = 1 \text{ mA}$

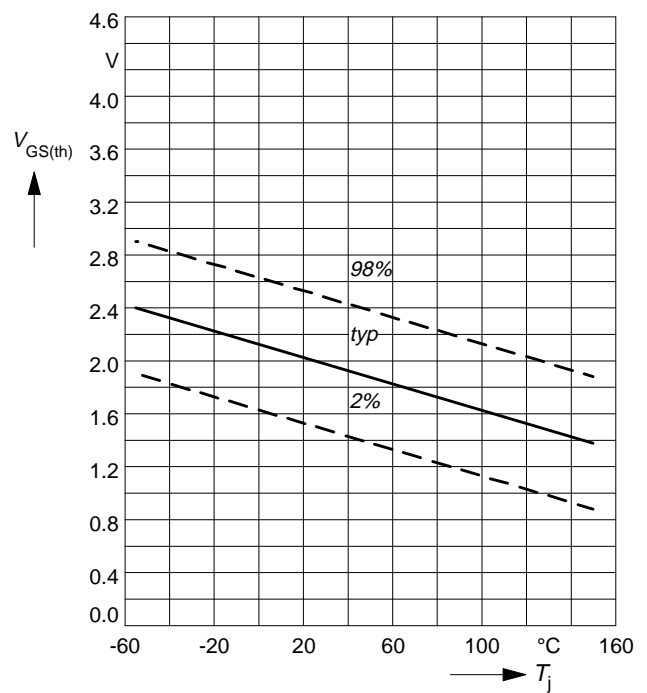

Typ. capacitances

$$C = f(V_{DS})$$

parameter: $V_{GS}=0\text{V}$, $f = 1 \text{ MHz}$

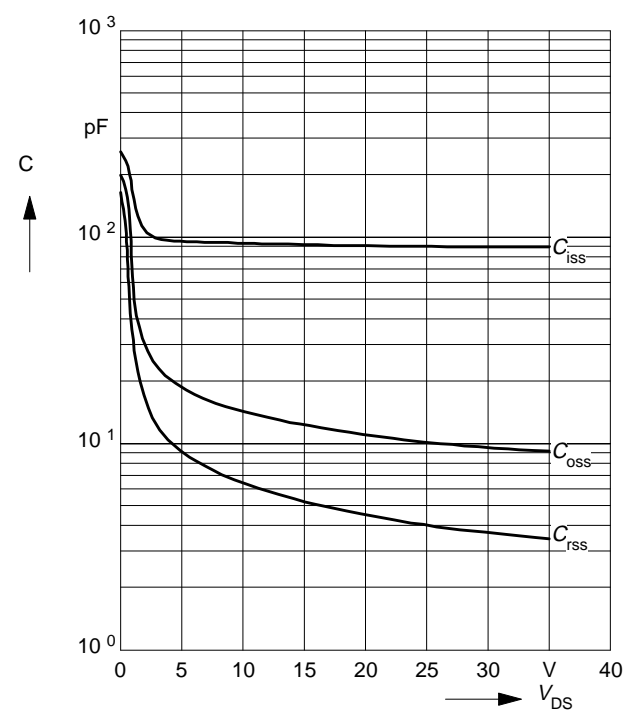

Forward characteristics of reverse diode

$$I_F = f(V_{SD})$$

parameter: $T_j, t_p = 80 \mu\text{s}$

